

Sürme Serileri

Küçük Tuba Sürme Serisi

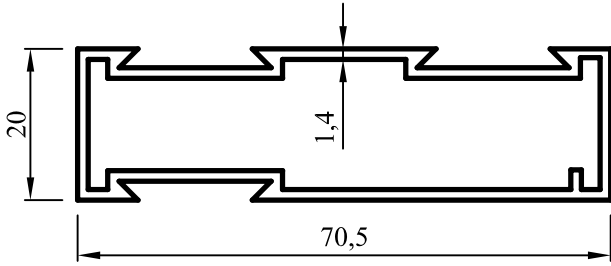

No : 1759

Kasa
0,830 kg/m

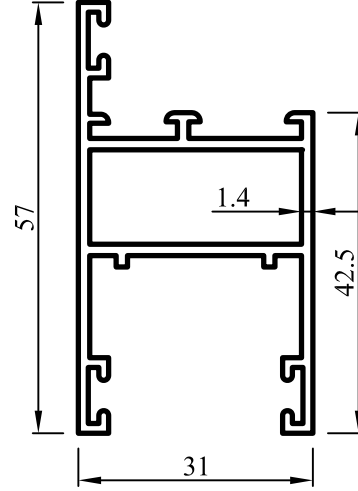

No : 1758

Kanat
0,760 kg/m

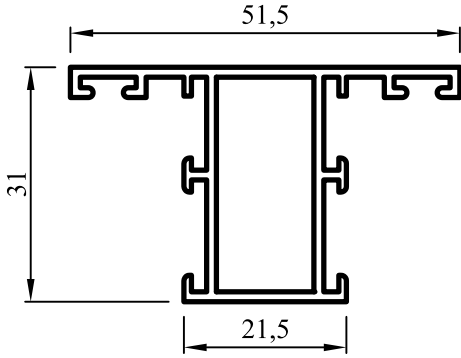

No : 1807

Orta Kayıt
0,590 kg/m

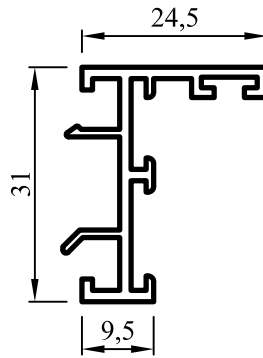

No : 1761

Sabit Kasa Adaptörü
0,370 kg/m

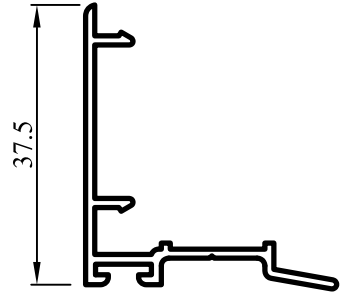

No : 1760

Kenet Adaptörü
0,310 kg/m

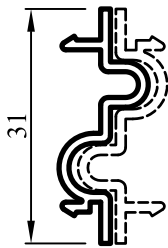

No : 1764

Orta Kenet
0,230 kg/m

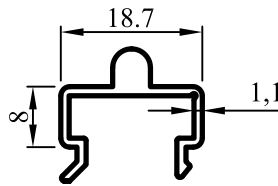

No : 1762

Alt Ray
0,225 kg/m

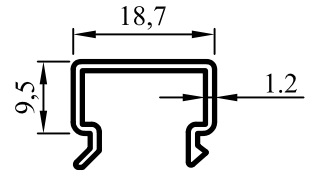

No : 1766

Yan ve Üst Ray
0,160 kg/m

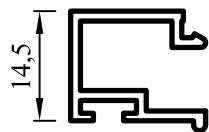

No : 1763

Tek Cam Çıtası
0,220 kg/m

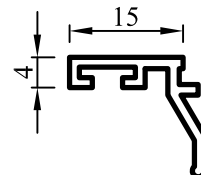

No : 1765

Isı Cam Çıtası
0,160 kg/m

Sürme Serileri

Büyük Tuba Sürme Serisi

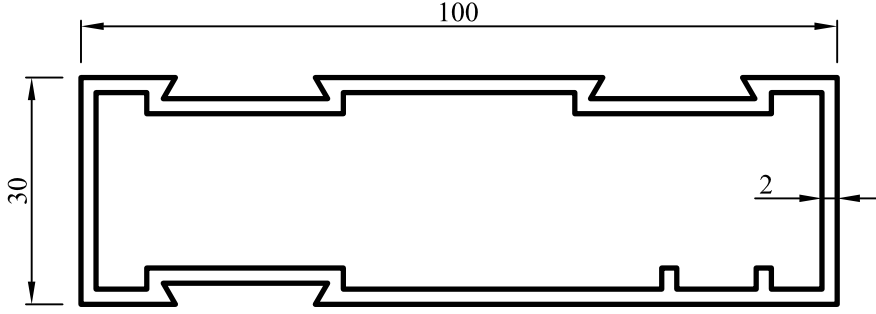

No : 1796

Kasa
1,540 kg/m

No : 1794

Kanat
1,360 kg/m

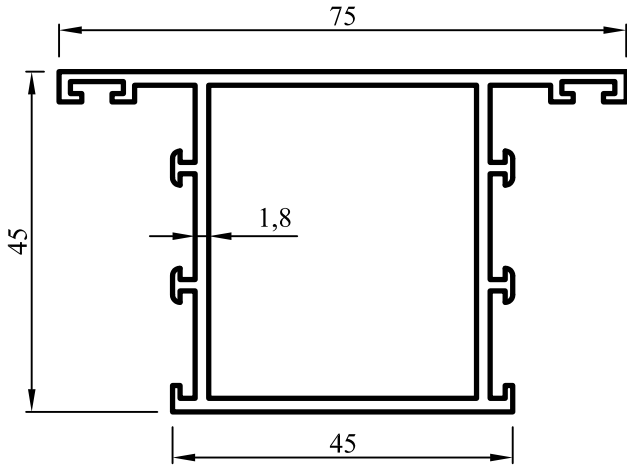
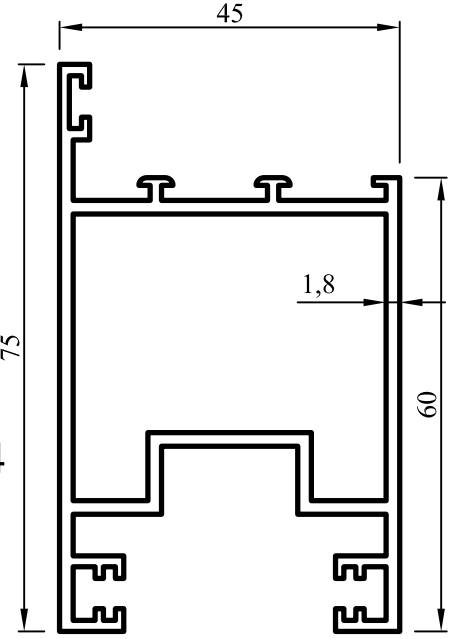

No : 1770

Orta Kayıt
1,120 kg/m

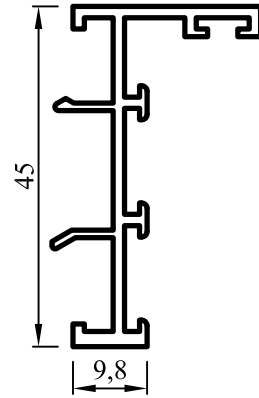

No : 1798

Sabit Kasa Adaptörü
0,460 kg/m

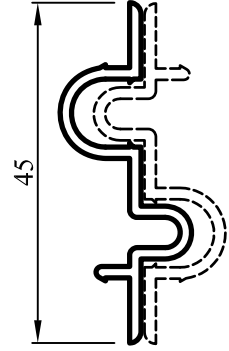

No : 1800

Orta Kenet
0,310 kg/m

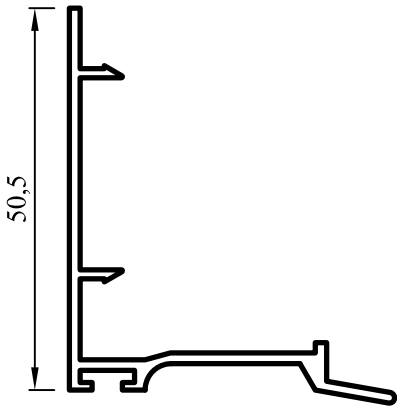

No : 1799

Kenet Adaptörü
0,440 kg/m

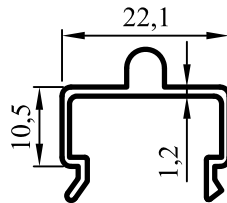

No : 1793

Alt Ray
0,235 kg/m

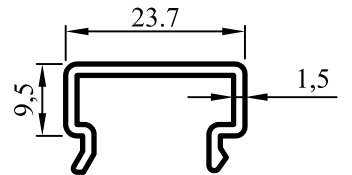

No : 1767

Yan ve Üst Ray
0,230 kg/m

Sürme Serileri

Büyük Tuba Sürme Serisi

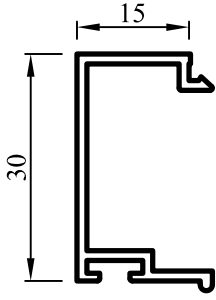

No : 1795

Tek Cam Çıtası
0,270 kg/m

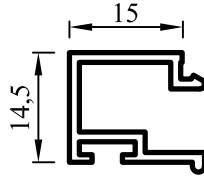

No : 1763

Isı Cam Çıtası
0,220 kg/m

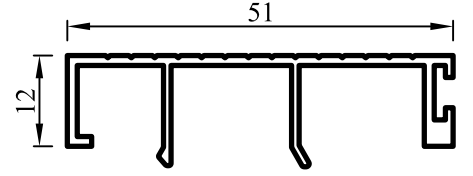

No : 1792

Kasa Kapağı
0,370 kg/m

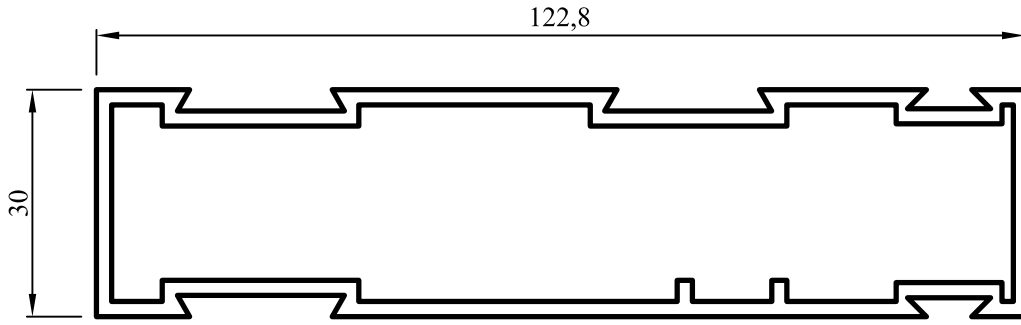

No : 1806

B. Tuba Sineklikli Kasa
1,810 kg/m

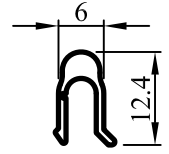

No : 1811

Sineklik Rayı
0,100 kg/m

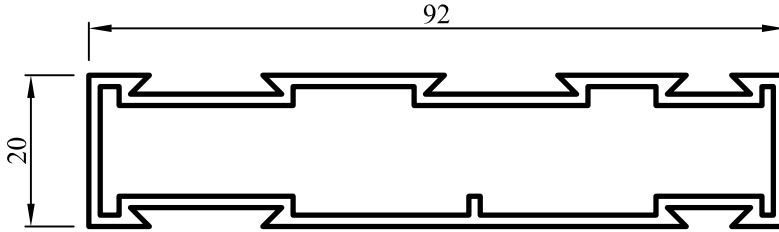

No : 1808

K. Tuba Sineklikli Kasa
1,100 kg/m

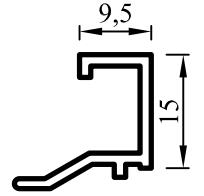

No : 1810

Sineklik Çıtası
0,190 kg/m

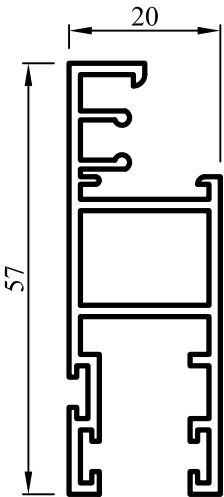

No : 1809

Sineklik Kanadı
0,730 kg/m

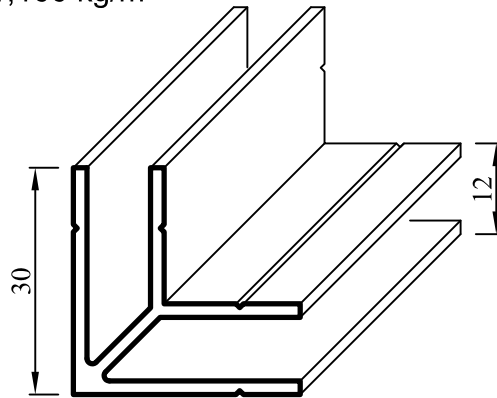

No : 1768

K. Tuba Bağlantı
0,540 kg/m

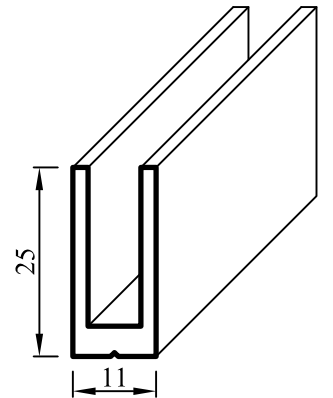

No : 1769

K. Tuba Dik Bağlantı
0,350 kg/m

Sürme Serileri

Küçük Tuba Sürme Serisi

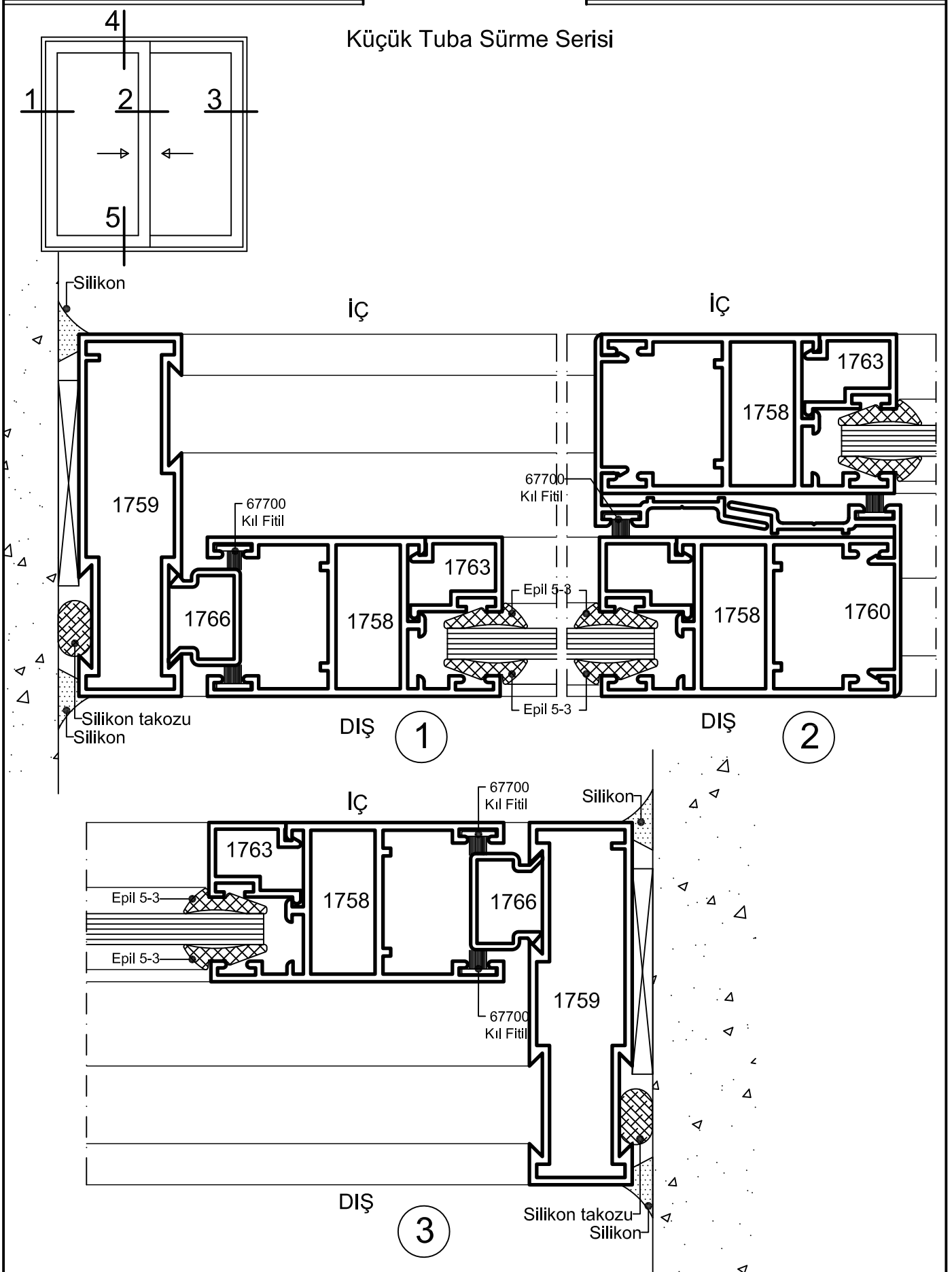

Sürme Serileri

Küçük Tuba Sürme Serisi

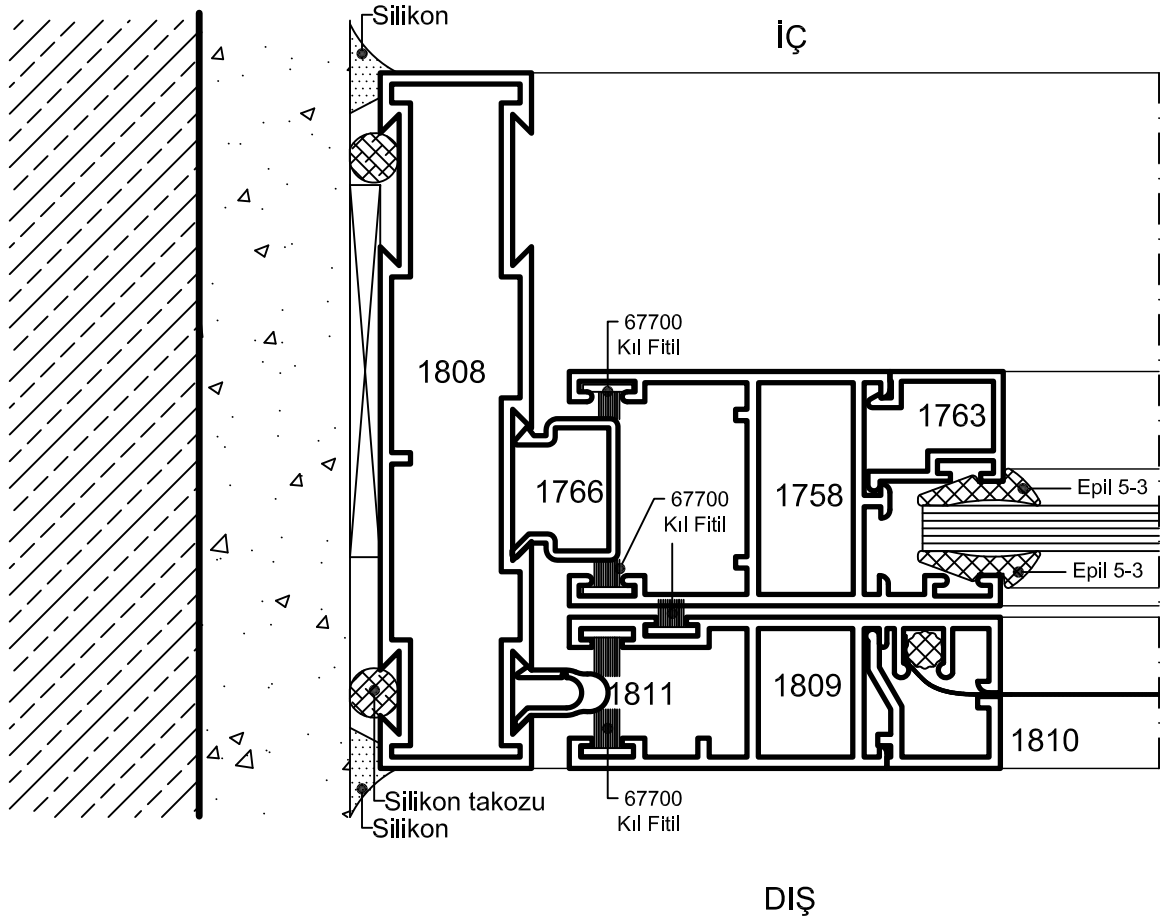
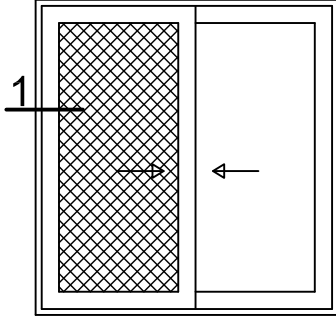

Sürme Serileri

Büyük Tuba Sürme Serisi

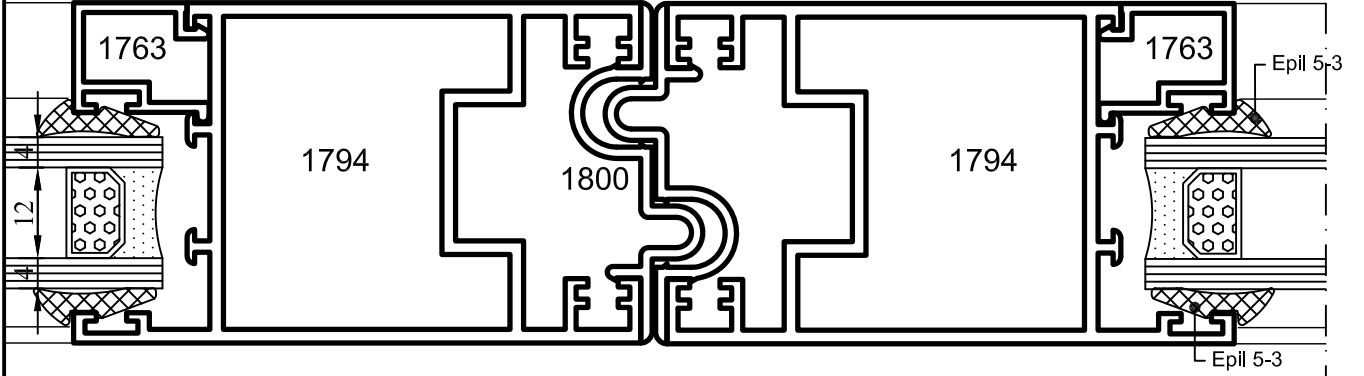

3

DIŞ

4

İÇ

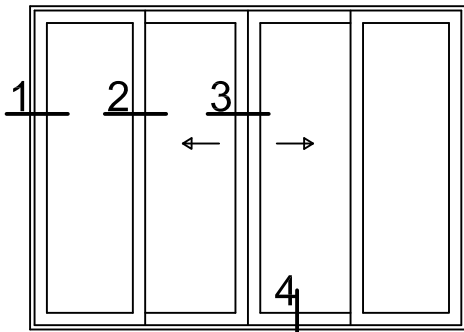

Silikon
Silikon Takozu

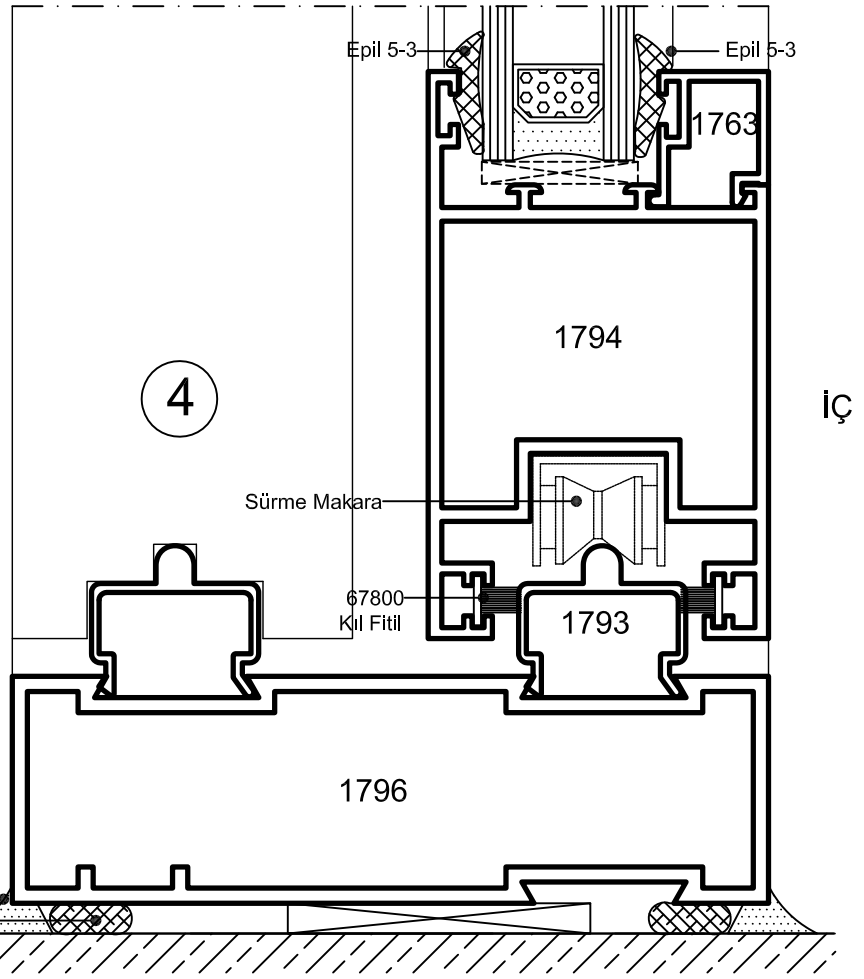

Sürme Serileri

Büyük Tuba Sürme Serisi

